

<b>Codice Prodotto</b> <i>Product Code</i>	<b>9.267.034.10</b>	 <b>Fornito Privo di Lubrificante!</b> <b>Supplied without oil!</b>
<b>Descrizione</b> <i>Description</i>	<b>T-27A</b>	

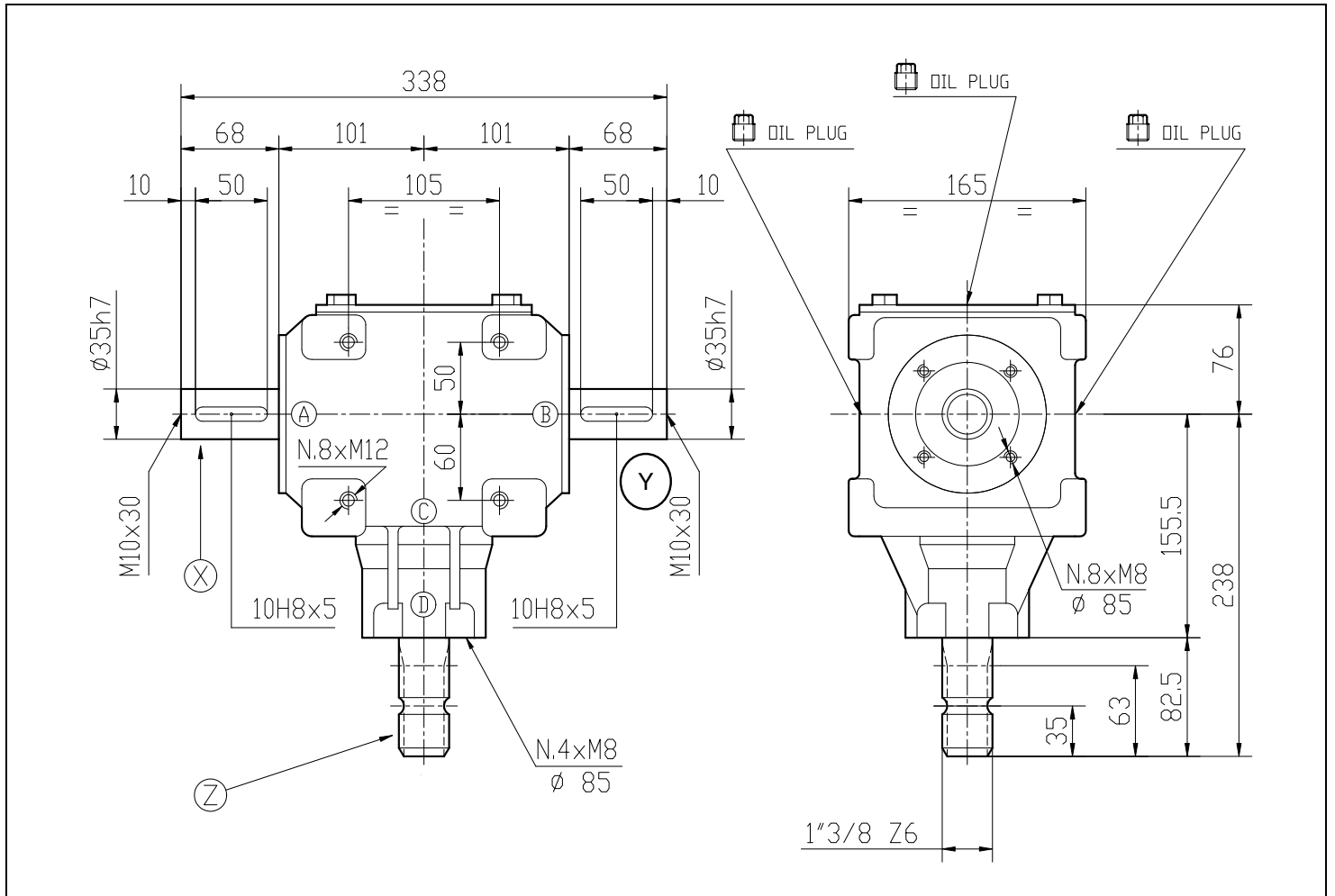
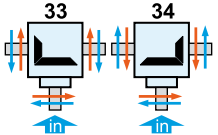
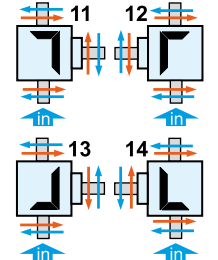

Tipo * Type *	Rapporto Ratio	Giri entrata Input r.p.m.	Potenza entrata Input Power [kW]	Momento Torcente Uscita Output Torque [daNm]	Peso Weight [kg]	Albero Ingresso Input shaft	Sensi di Rotazione Direction of Rotation
M	1:1,92	540	22,1	19,7	18,8	<b>Z</b>	
R	1,92:1	540	15,1	49,6		<b>X-Y</b>	

\* Tipo: M= Moltiplicatore di Giri R= Riduttori di Giri O= Rinvio 1:1 RC= Riduttore Cambio di Velocità MC= Moltiplicatore Cambio di Velocità  
 \* Type: M= Speed Increaser R= Reducer O= Gearbox 1:1 RC= Speed-Change Reducer MC= Speed-Change Increaser